



R. FOAM  
N. FOAM



WOOD

# NEVADA

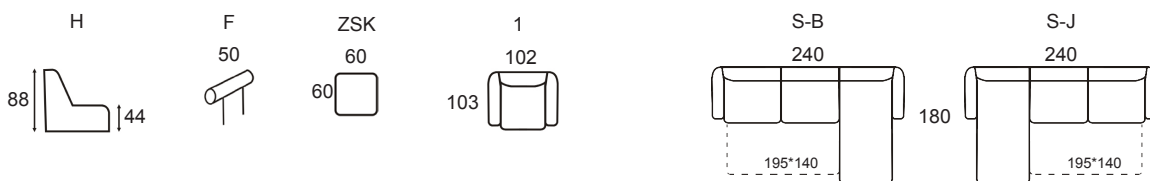

NORMAL  
FOAM



# LAURA

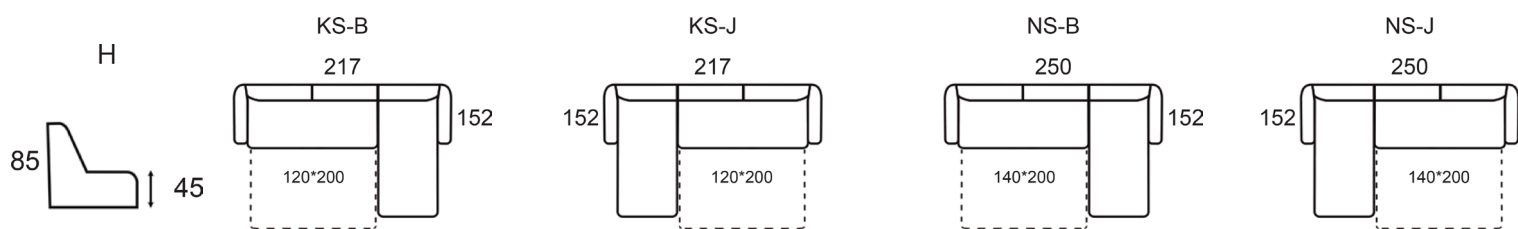

MARCO 85



MARCO 85  
115

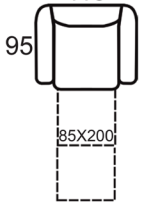
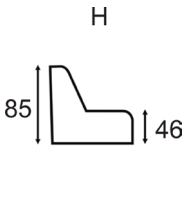

MARCO 120



MARCO 120  
149

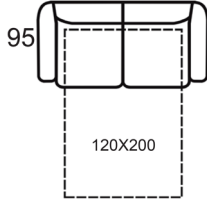

MARCO 140



MARCO 140  
169

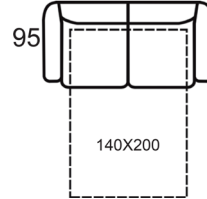

FF= 32cm H

FLORIDA 85



FLORIDA 85  
121

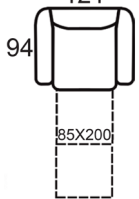

FLORIDA 120



FLORIDA 120  
155

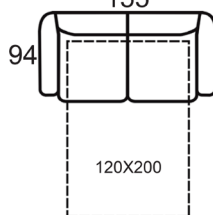

FLORIDA 140



FLORIDA 140  
175

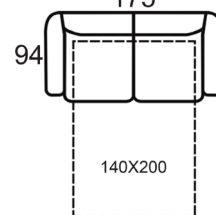

FF= 32cm H

LAURA 120



LAURA 140



NORMAL FOAM

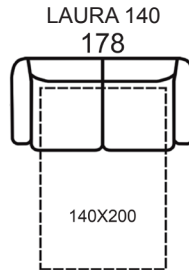
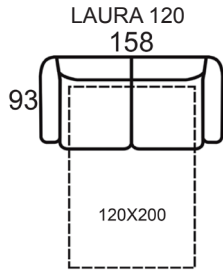
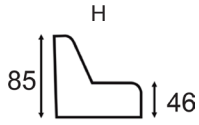

DOMINO 120



DOMINO 140



NORMAL FOAM

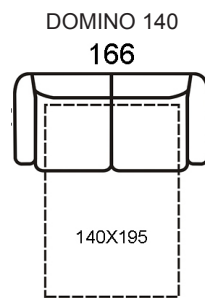
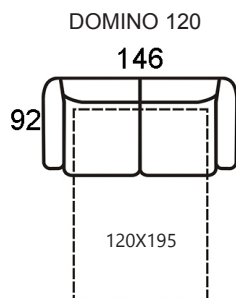
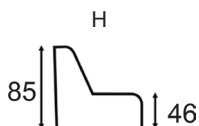

**BERGEN**



260X172



R. FOAM  
N. FOAM

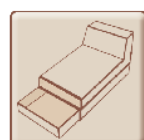
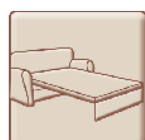

WOOD

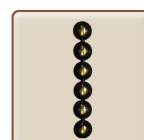

S-B

S-J



FF=195\*140

H

S-B

S-J

260

260

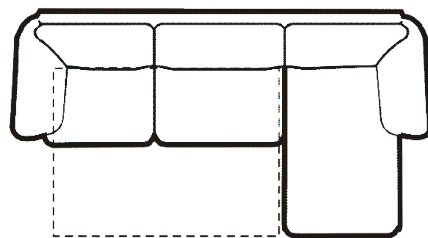

172

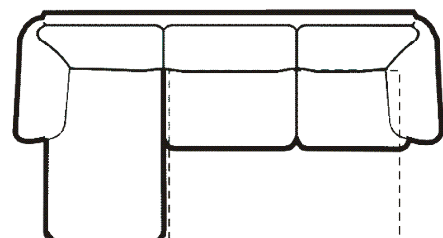



# LUXOR



3/NY - 2 - 1



FF=190\*140

1/RELAX-M

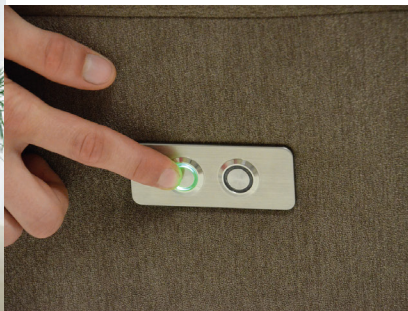

ZSK



1



1/RELAX-M



2



2/2 RELAX-M



3



3/2 RELAX-M



3/NY



E-B



E



2E



E-J



E/RELAX-MB



E/RELAX-MJ



3E-B



3E-J



3E/NY-B



3E/NY-J



SEN



H



ZSK



1



1/RELAX-M



2



2/2 RELAX-M



3

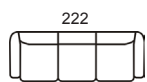

3/2 RELAX-M



3/NY

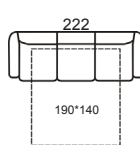

190\*140

E-B



E



2E



E-J



E/RELAX-MB

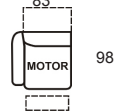

E/RELAX-MJ

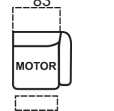

SEN

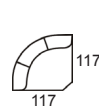

3E-B

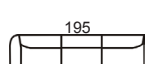

3E-J

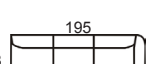

3E/NY-B

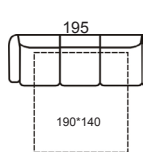

3E/NY-J

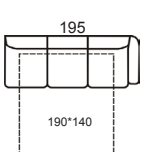

190\*140

# SANTIAGO



NORMAL  
FOAM



SANTIAGO 140



SANTIAGO 160



# BERGAMO



NORMAL  
FOAM

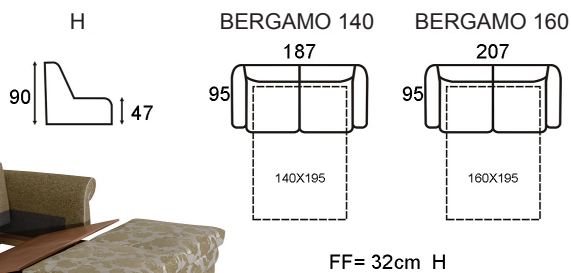

BERGAMO 140



BERGAMO 160





# LORD

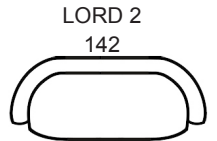
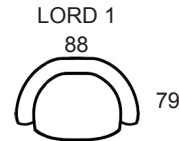
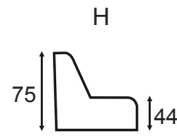

# CARLOS

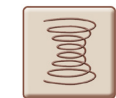
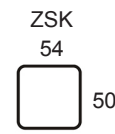
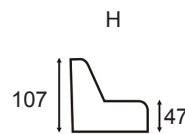

# GIO

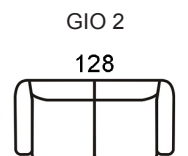
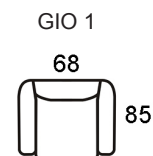
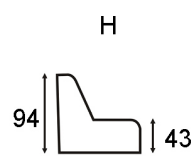

VALENCIA



2,5/NY - 2 - 1/LT-M

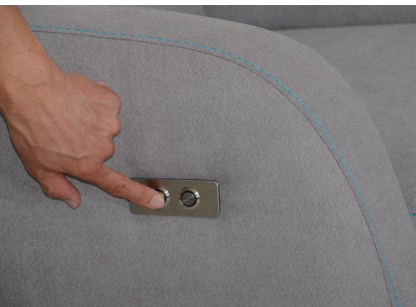

ZSK

1

1/LT-M

2

2,5

2,5/NY



H

ZSK

1

1/LT-M

2

2,5

2,5/NY

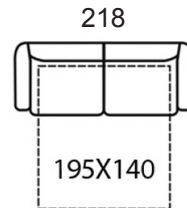
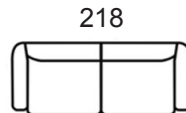
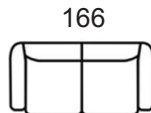
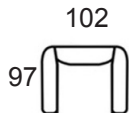
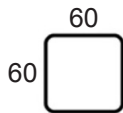



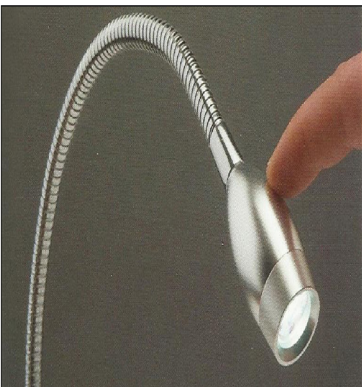

**MIAMI**

269X310 KAR XPL-B + 2E/NY-B + SEPO + E + KARPO-CH+USB+L + E/LT-MJ + KAR-J



259X269 KAR-B + E-B + E + SEPA + 2E/NY-J + KAR XPL-J

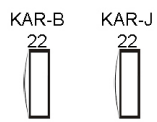
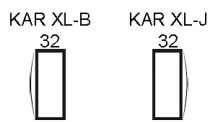
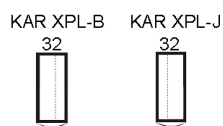
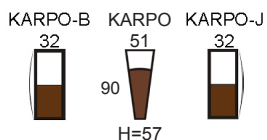
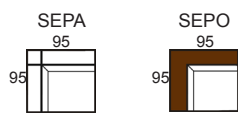
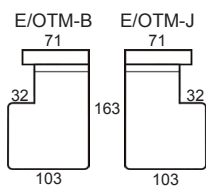
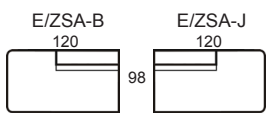
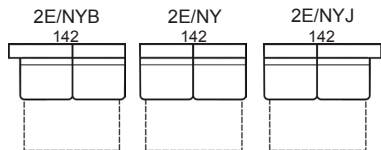
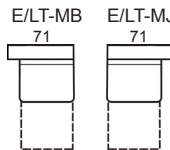
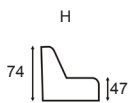
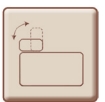

## DALIA II.

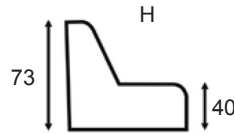

DALIA II.  
93



## GRIFF

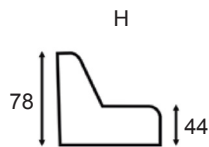

GRIFF 1  
79



GRIFF 2  
137



## FANNY

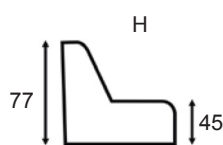

FANNY 1  
77



FANNY 2  
125





CHESTER

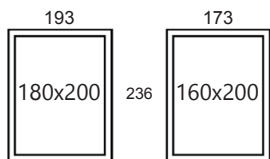
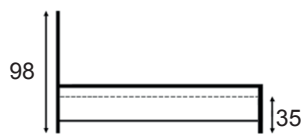

CLEOPATRA

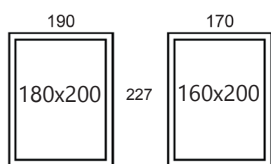
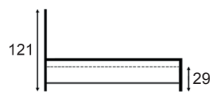

LEO

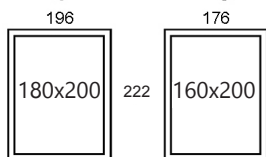
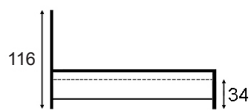

# VIRGINIA



167X399

E/OTM-B + F + 2E/NY + KARPO + E/LT-J + F



202X270

E/ZSA-B + SEPA + 2E/NY-J

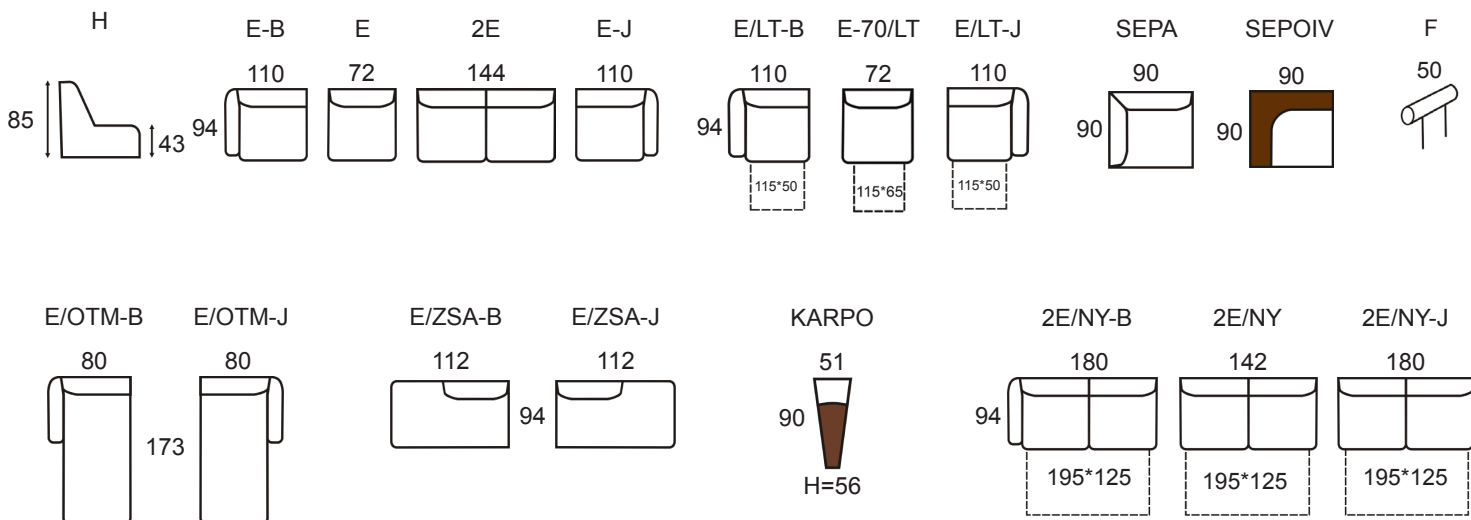

# VIRGINIA



270X213

2E/NY-B + F + SEPO + E/LT + F + KARPO-CH+USB+L



323X270

E/LT-B + F + KARPO + E + SEPOIV + 2E/NY-J + F



# LORENZO

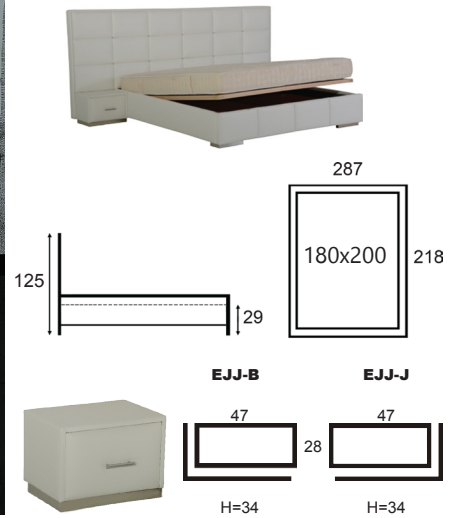

# ALIZ

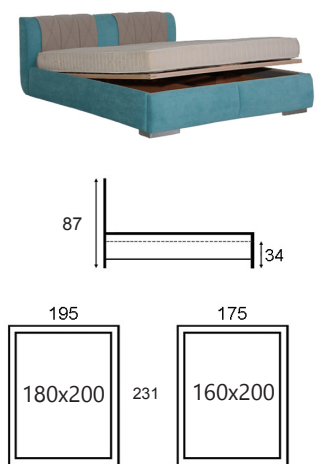
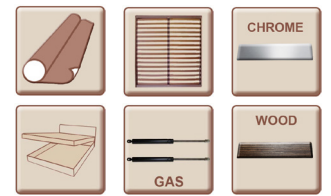

# KARO

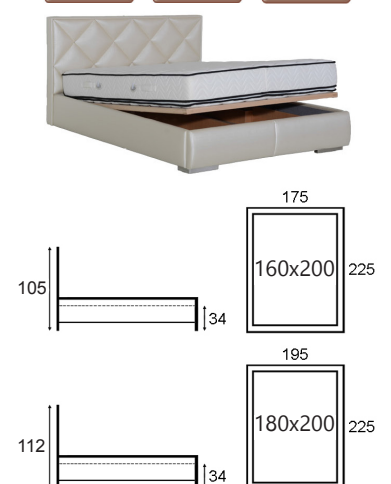

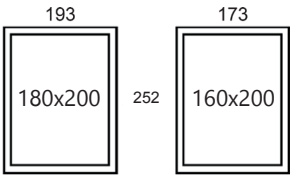
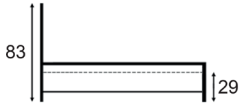

## MILLENIUM

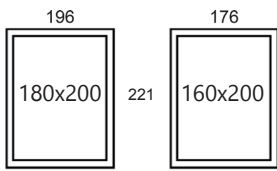
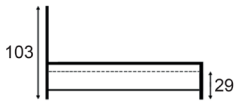
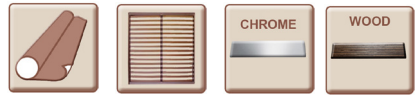

## PENELOPE

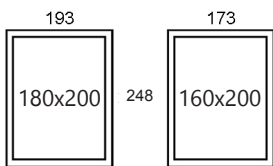
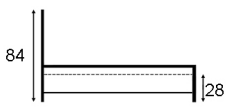
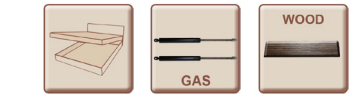
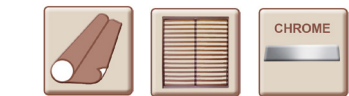

## MODEL: FFL - 21



# MONTREAL



261X211

2E/NY-B + SEPA + E/ZSA-J



293X167

2E/NY-B + E/OTM + F + KARPO

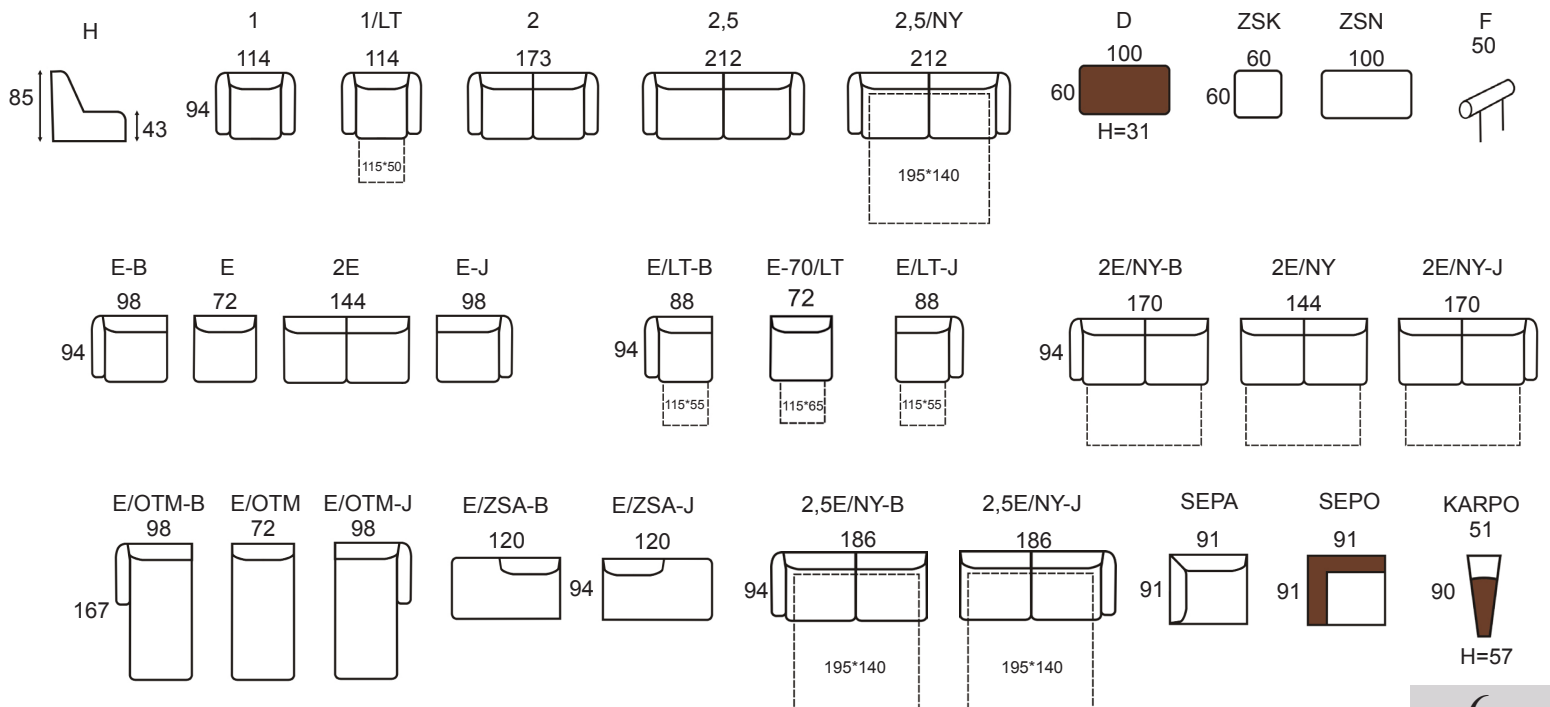





**MONTREAL**

302X261

E/LT-B + F + KARPO-CH+USB+L + E + F + SEPO + 2E/NY-J



2 + 2,5NY + 1 + F



1	1/LT	2	2,5	2,5/NY	D	ZSK	ZSN	F	
E-B	E	2E	E-J	E/LT-B	E-70/LT	E/LT-J	2E/NY-B	2E/NY	2E/NY-J
E/OTM-B	E/OTM	E/OTM-J	E/ZSA-B	E/ZSA-J	2,5E/NY-B	2,5E/NY-J	SEPA	KARPO	
							SEPO		



BELLAGIO

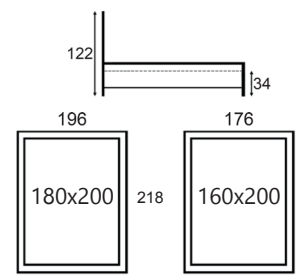
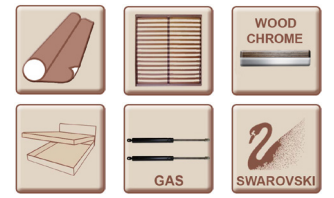

MODEL: FNI - 22

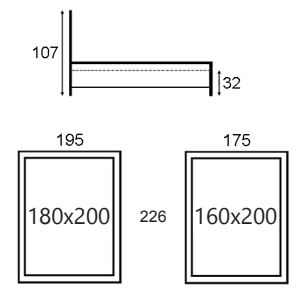
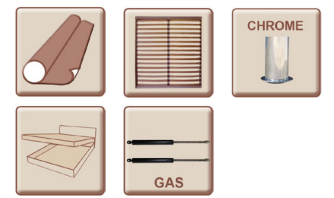

IBIZA

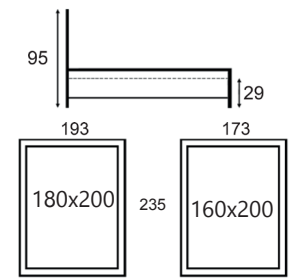
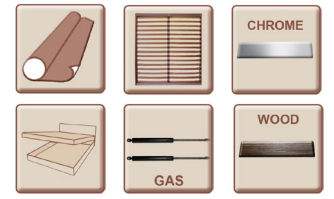



## RAMONA

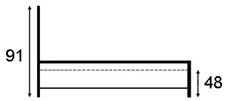
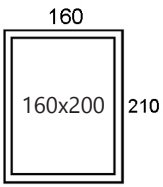

## ALEX

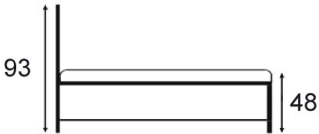
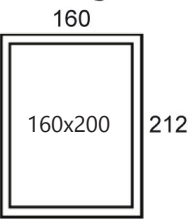

## ADEL

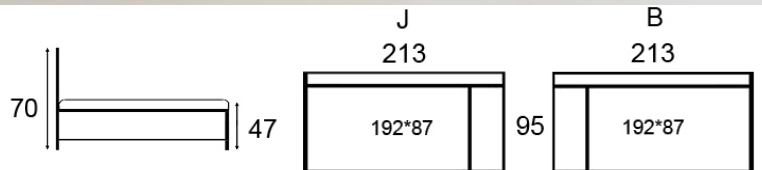

# MILLENIUM















269X215

KARPO-B + 2E/NY-B + SEPA + E/ZSA-J



300X259

KAR XL-B + E/OTM-B + 2E/NY-J + KARPO-J

- 
- 
- 
- 
- 
- 
- 
- 
- 
- 
- 
- 

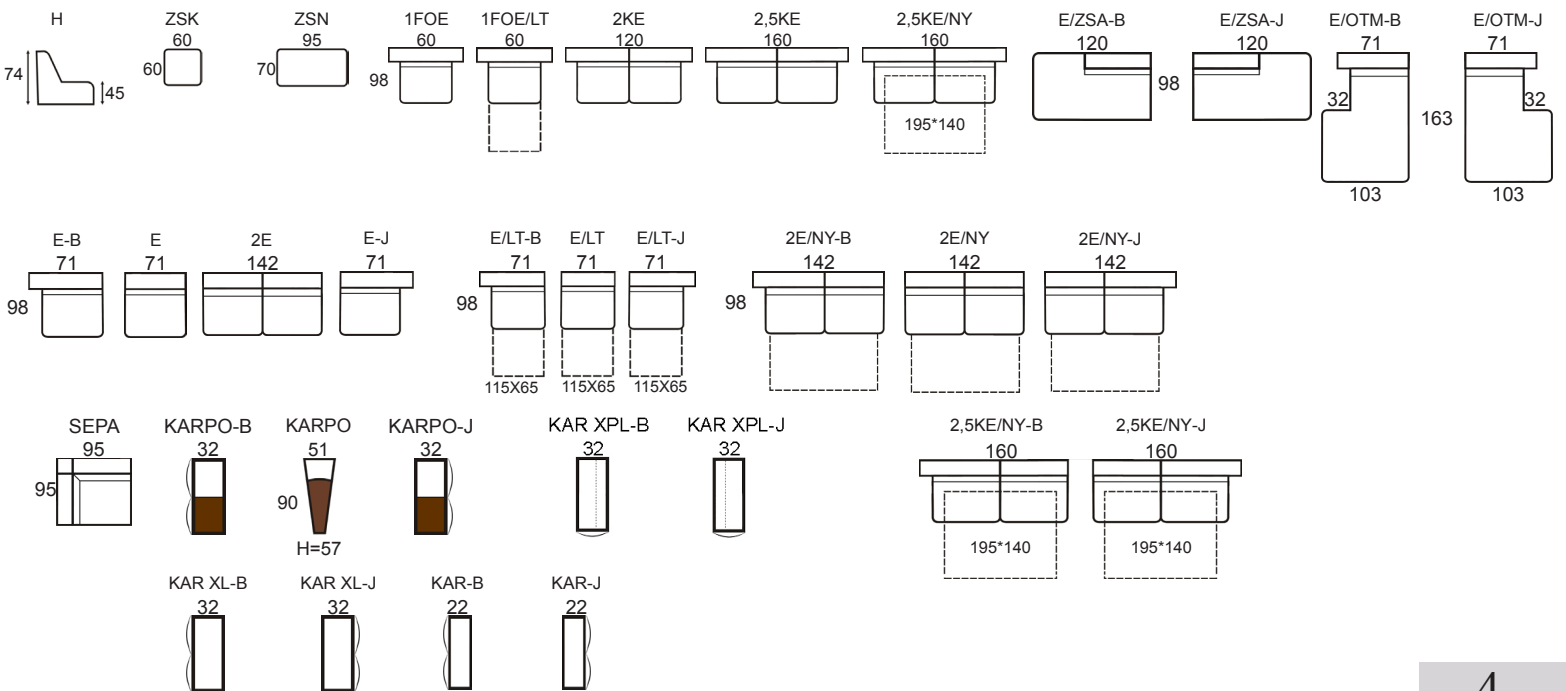



**MILLENIUM**

269X310

KAR XPL-B + 2E/NY-B + SEPA + E + KARPO-CH+USB+L + E/LT-J + KAR-J



KAR XL-B + 2,5KE/NY + KAR XL-J  
 KAR XL-B + 2KE + KAR XL-J  
 KAR XL-B + 1FOE + KAR XL-J

ZSK	ZSN	1FOE	1FOE/LT	2KE	2,5KE	2,5KE/NY	E/ZSA-B	E/ZSA-J	E/OTM-B	E/OTM-J
E-B	E	2E	E-J	E/LT-B	E/LT	E/LT-J	2E/NY-B	2E/NY	2E/NY-J	
SEPA	KARPO-B	KARPO	KARPO-J	KAR XPL-B	KAR XPL-J	2,5KE/NY-B	2,5KE/NY-J			
	KAR XL-B	KAR XL-J	KAR-B	KAR-J						

MODEL: HDO - 24

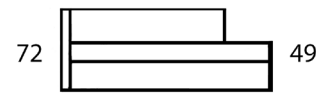
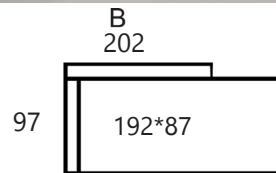
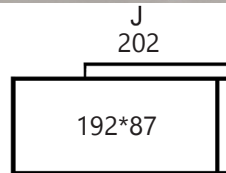
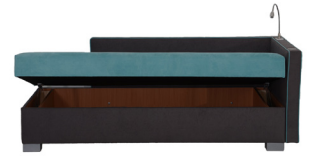

MODEL: HLO - 24

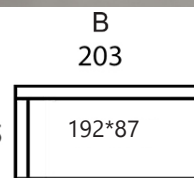
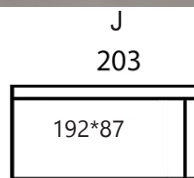
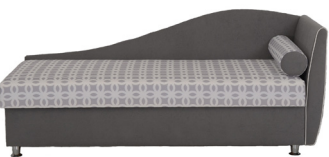
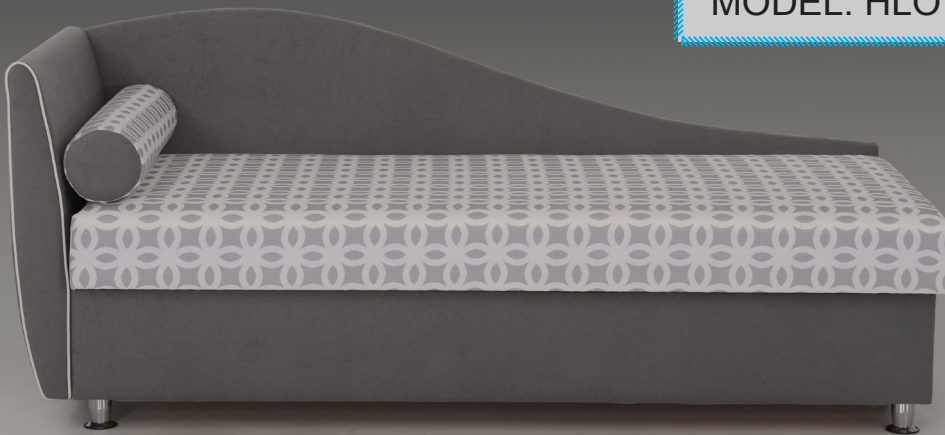

FLAMINGO II.

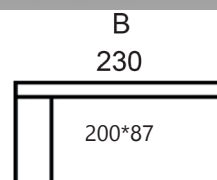
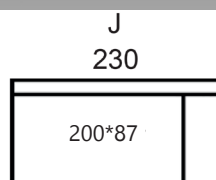

HEVERO FR-C 90

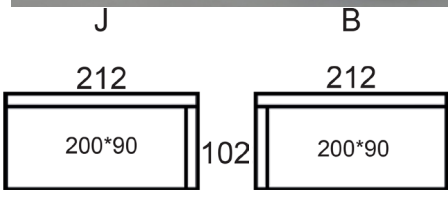
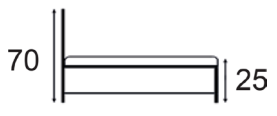

ALADIN

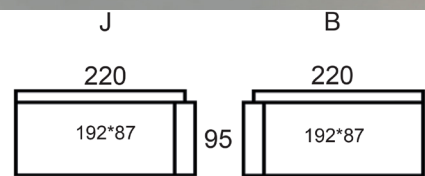
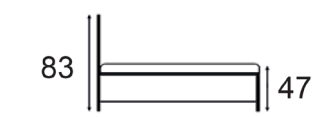

DORINA

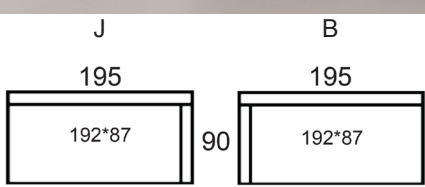
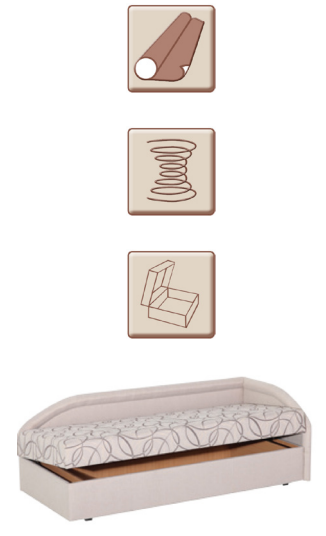

# TORINO



264X170

2E/NY-B + E/OTMPO-J + F



211X259

E/ZSA-B + SEPA + 2E/NY-J

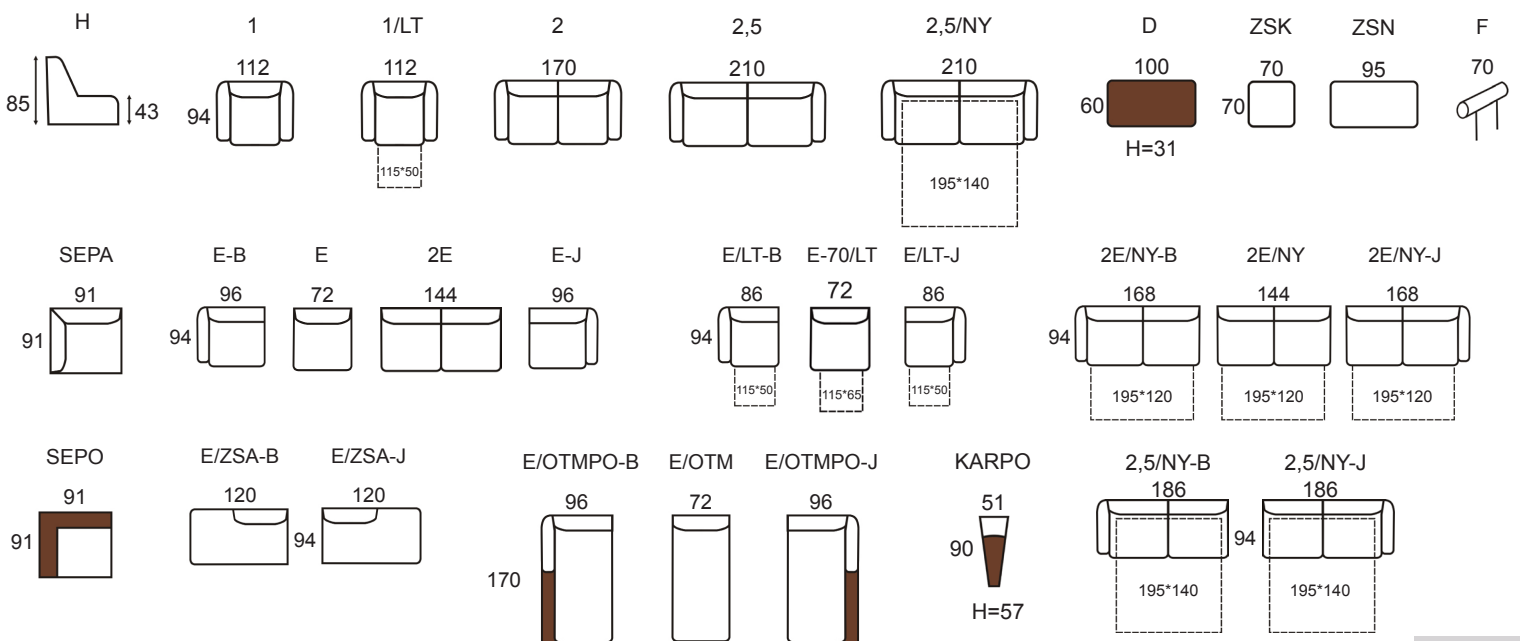
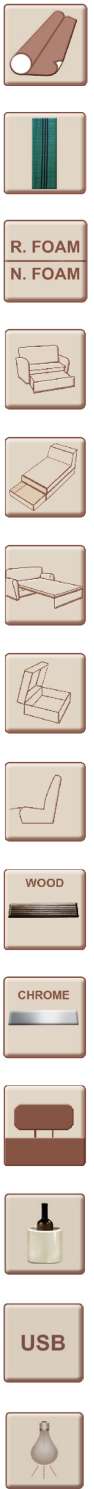





**TORINO**



300X259

E/LT-B + F + KARPO-CH+USB+L + E + SEPA + 2E/NY-J + F



2,5/NY + 2 + 1 + F + D

1	1/LT	2	2,5	2,5/NY	D	ZSK	ZSN	F		
SEPA	E-B	E	2E	E-J	E/LT-B	E-70/LT	E/LT-J	2E/NY-B	2E/NY	2E/NY-J
SEPO	E/ZSA-B	E/ZSA-J	E/OTMPO-B	E/OTM	E/OTMPO-J	KARPO	2,5/NY-B	2,5/NY-J		

## KARPO CH



## KARPO CH + USB



## KARPO CH + USB + L



## ÉJJELI SZEKRENY



52X36 H=39

## ÉJJELI 2 FÍÓKOS 45 LÁB



45mm

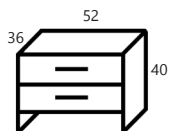

## ÉJJELI 2 FÍÓKOS 100 LÁB



100mm

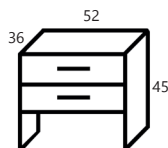

## ÉJJELI 2 FÍÓKOS 130 LÁB



130mm

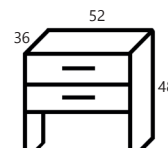

## ITALTARTÓ



51X32

## KÖRPUFF



Ø=38 cm H=42

## TEKNŐS



Ø= 60 cm

## BABZSÁK FÜLES



200 L

## BABZSÁK FOCIS





Elérhetőségek:  
8000 Székesfehérvár Kiskút útja 1.  
Tel: (22) 506-705  
E-Mail: [albamobili@karpitosbutor.hu](mailto:albamobili@karpitosbutor.hu)  
Weboldal: [www.albamobili.eu](http://www.albamobili.eu)

KATALÓG NÁBYTKU  
BÚTOR KATALÓGUS  
2017



designed for fort

alba mobili